

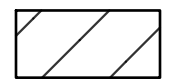

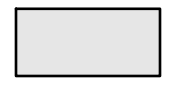



LEGEND

-  Work Area
-  Temporary Asphalt Pavement
-  Channelizer
-  Tubular Markers
-  Type III Barricade
-  Type III Barricade w/ Sign
-  Single Post/Skid Mounted Sign

Note:  
The Contractor shall install the advance warning signs according to the plans unless the Engineer specifies otherwise. The signs shall have a minimum spacing of 100' but shall be adjusted to avoid existing entrances and sideroads, if needed.

Existing pavement marking and signing in conflict with the proposed traffic control layout shall either be removed or covered with approved material in accordance with the City of Wichita Specifications and the City of Wichita Pre-Approved materials.

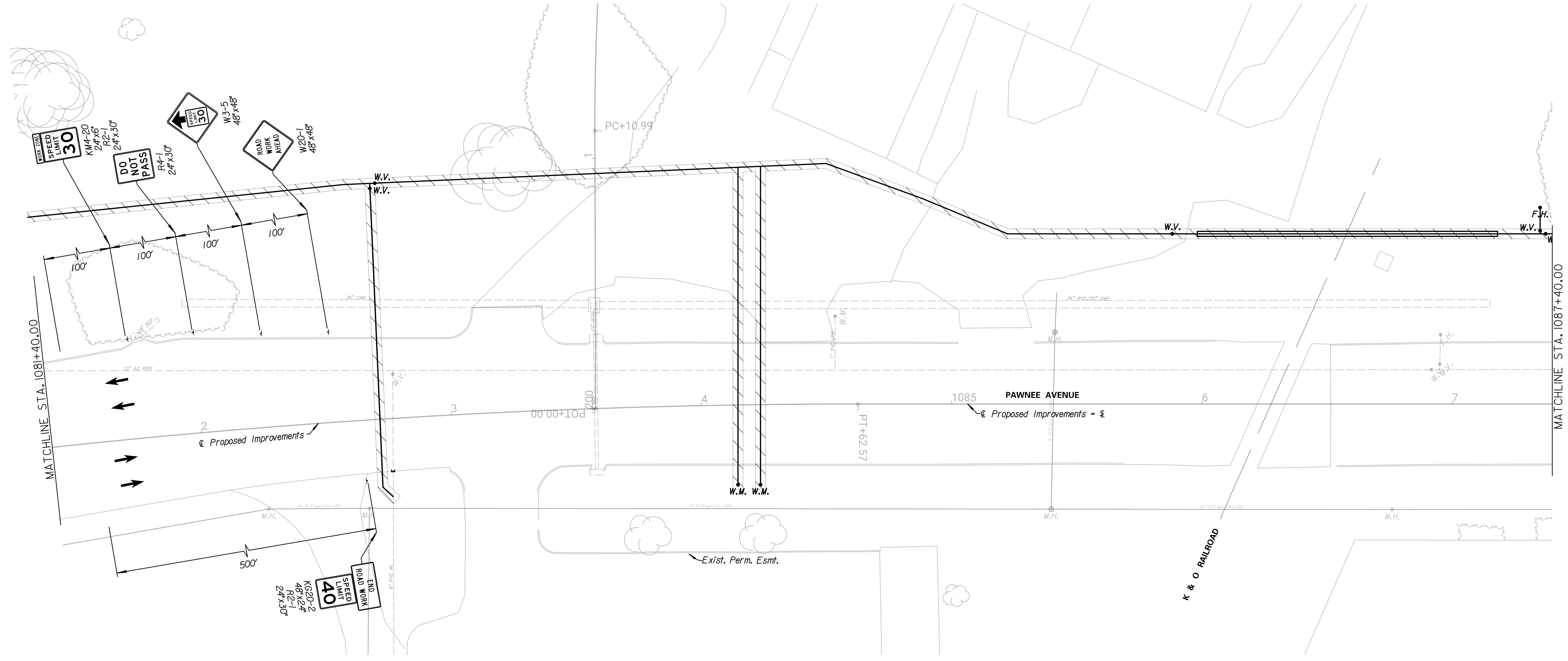
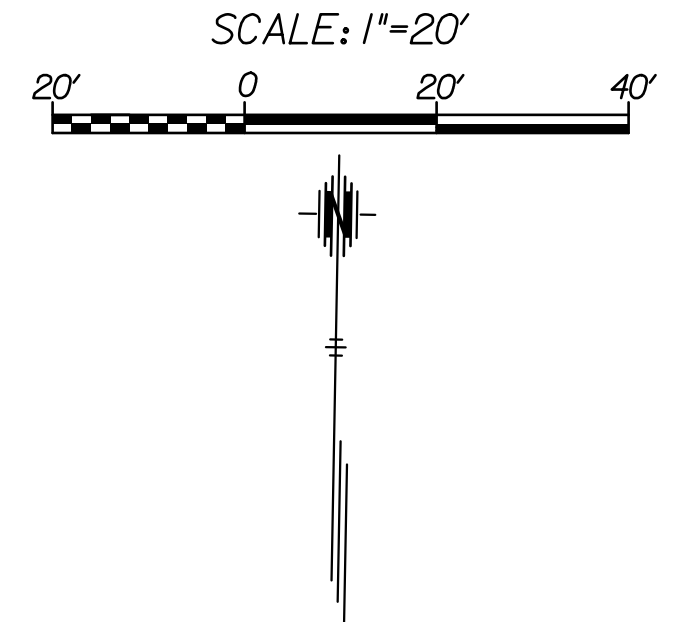

**TRANSYSTEMS**  
245 N. WACO  
SUITE 222  
WICHITA, KANSAS 67202  
MAIN: 316-303-3000  
FAX: 316-462-5629

CONSULTANTS:

WEST STREET IMPROVEMENTS  
FROM PAWNEE TO HARRY

WICHITA, KANSAS



REVISIONS:	MARK	DATE	DESCRIPTION

PROJ NO: 87 N-0720-01  
SCALE: 1"=20'  
DATE: 9/25/2023  
DESIGNED BY: LCV  
DRAWN BY: LCV  
CHECKED BY: MDB

SHEET TITLE:  
**PAWNEE AVENUE  
IMPROVEMENTS  
TRAFFIC CONTROL  
PHASE 1**

SHEET NO.  
**156**

9/25/2023 6:26:49 PM - c:\transystems\paw\_bowl\transystems\paw\1a-e\_krohs\d0984549\COP-W02-103.DGN