







LEGEND

-  Work Area
-  Temporary Asphalt Pavement
-  Channelizer
-  Tubular Markers
-  Type III Barricade
-  Type III Barricade w/ Sign
-  Single Post/Skid Mounted Sign

Note:  
 \*Type III Barricades and signs are to only be placed during construction through the entrance, sideroad, or through construction in the area. The Contractor shall open up the area after construction is complete to allow full access to traffic.

The Contractor shall install the advance warning signs according to the plans unless the Engineer specifies otherwise. The signs shall have a minimum spacing of 100' but shall be adjusted to avoid existing entrances and sideroads, if needed.

Existing pavement marking and signing in conflict with the proposed traffic control layout shall either be removed or covered with approved material in accordance with the City of Wichita Specifications and the City of Wichita Pre-Approved materials.

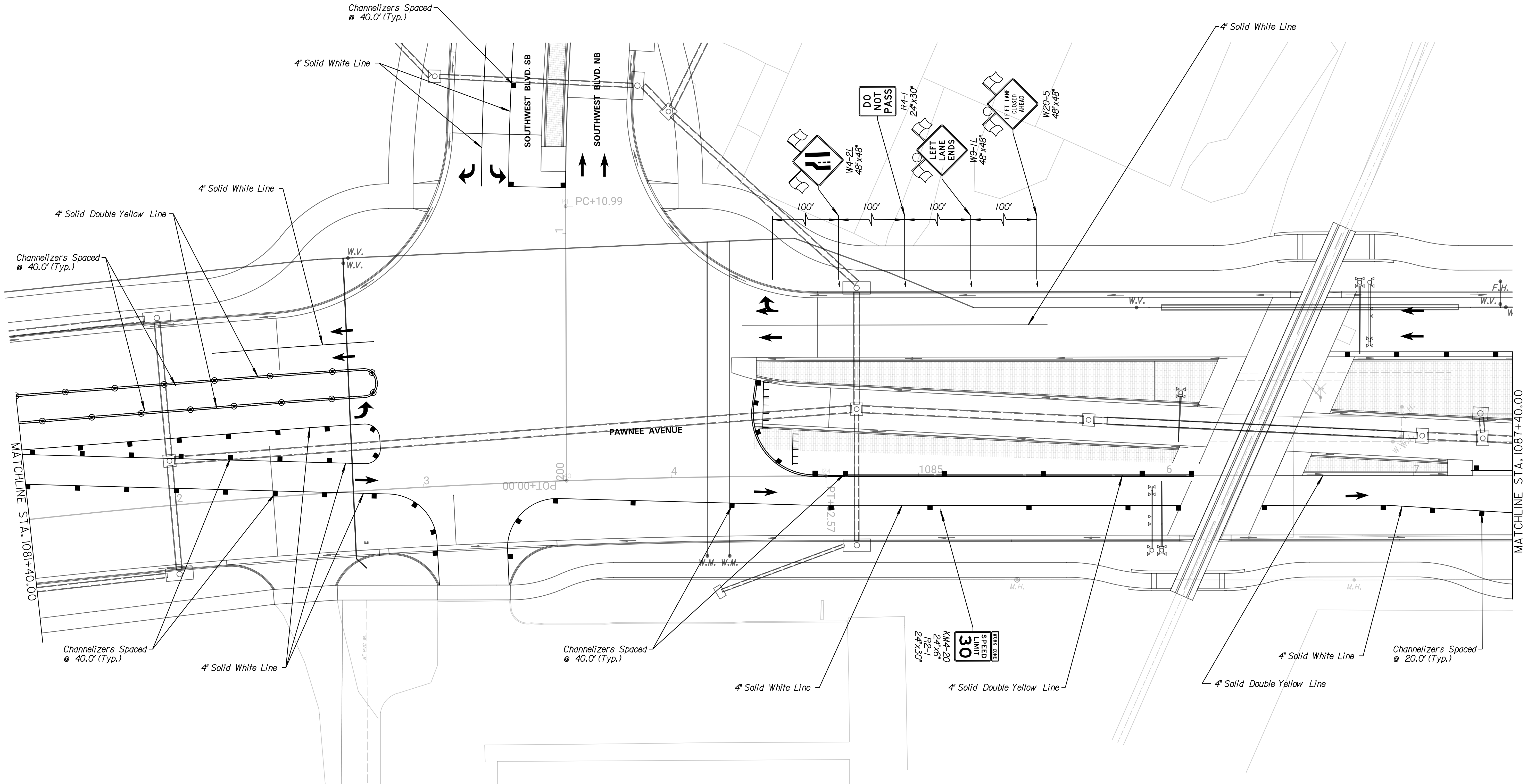
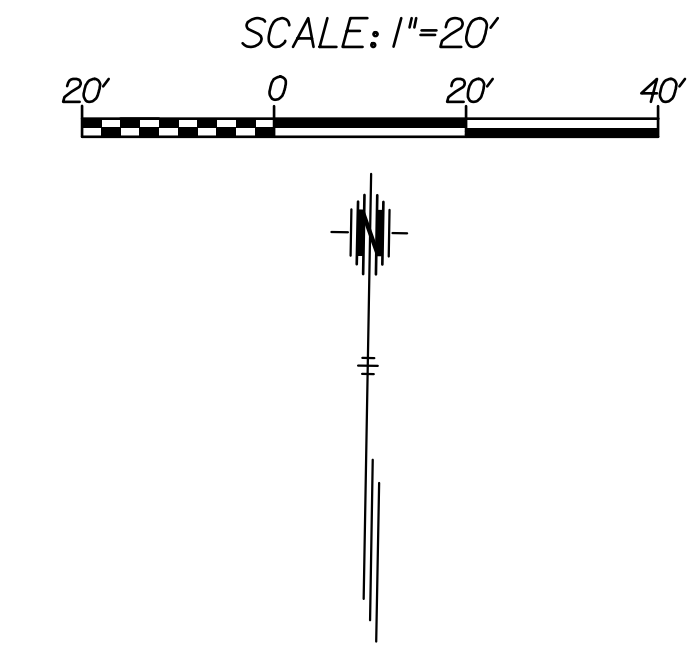

**TRANSYSTEMS**  
 245 N. WACO  
 SUITE 222  
 WICHITA, KANSAS 67202  
 MAIN: 316-303-3000  
 FAX: 316-462-5629

CONSULTANTS:

WEST STREET IMPROVEMENTS FROM PAWNEE TO HARRY  
 WICHITA, KANSAS  

REVISIONS:	MARK	DATE	DESCRIPTION

PROJ NO: 87 N-0720-01  
 SCALE: 1"=20'  
 DATE: 9/25/2023  
 DESIGNED BY: LCV  
 DRAWN BY: LCV  
 CHECKED BY: MDB

SHEET TITLE:  
**PAWNEE AVENUE IMPROVEMENTS TRAFFIC CONTROL PHASE 4B**

SHEET NO.  
**260**

9/25/2023 8:36:22 PM - c:\transystems\work\local\transystems\proj\1a-w\_1\work\87n0720-01\CP-01\211.DGN